

Masonry reinforcement Product Selector



Introduction

Bekaert Building Products has been at the forefront of masonry reinforcement design and product development for over 80 years. Brickforce® has been in continuous use since its introduction in 1918. To cater for the increased use of masonry construction and to offer masonry reinforcement solutions for modern build requirements Bekaert continues to develop its range of products. Bricktor® CCR and Bricktie have been designed and introduced for specific applications. Following the introduction of the BS 5628-2 reinforced masonry design code, Bekaert introduced an extensive Brickforce® range which continues to be unique and unequalled for reinforced masonry construction applications.



Product Selector

The following table indicates which products may be suitable for different types of applications. The suitability for a specific application should be confirmed by referring to the appropriate Bekaert technical publication or by contacting the Bekaert sales office.

Application guide

Product	Brickforce® Structural	Bricktie Cavity Walls	Bricktor® Crack control
Application	page 4	page 5	pages 6-7
Lateral load-wind	✓	✓	
Windpost reduction	✓	✓	
Line loads/crowd barriers	✓	✓	
Retaining walls	✓	✓	
Blockwork lift shafts	✓	✓	
Top rail/support removal	✓	✓	
Crack control - openings	✓	✓	✓
Crack control - settlement	✓	✓	✓
Crack control - changes in profile	✓	✓	✓
Crack control - load spread	✓	✓	
Beams	✓	✓	
Internal walls on suspended slab	✓	✓	
Collar jointed separation/fire wall		✓	
Lintels	✓	✓	
Wall connections	✓	✓	✓
Corbelled brickwork	✓	✓	
Rendered finishes	✓	✓	✓
Stack-bond blocks & bricks	✓	✓	
Thin joint construction	✓		✓
Radiused brickwork/blockwork	✓	✓	
Movement joints	✓	✓	✓
Tie wall leaves together		✓	

There are two main areas of use for masonry reinforcement:

Structural

Where masonry reinforcement has been designed and specified to increase the load bearing capacity of masonry construction in accordance with BS5628 Part 2 - the design code for reinforced masonry.

Crack control

Where masonry reinforcement is specified to assist in control of cracking in areas of stress concentration or thermal and moisture movement as covered by BS5628 Part 3.

To ensure that the products comply, in addition to material testing during production, Bekaert is committed, as part of our technical development, to an on-going testing programme.



Destruction testing of un-reinforced wall

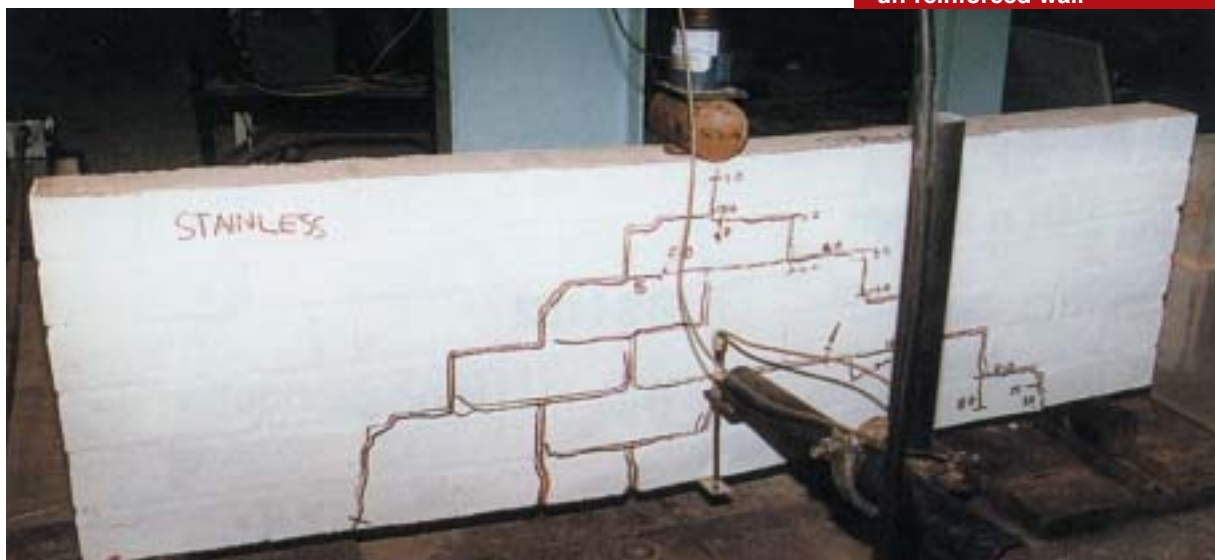

Test loading being applied to reinforced wall

We acknowledge the help of Ceram Building Technology Stoke-on-Trent

Brickforce®

The structural reinforcement

Brickforce® is designed for **structural reinforced masonry applications**. Brickforce® complies fully with the requirements of the Reinforced Masonry Design Code - BS 5628-2, and consists of two main parallel wires joined by in-line welded cross wires.

The main wires are manufactured to a flattened profile to enable the product to be **easily located into the mortar joint** without steel build-up problems at lap positions corners/junctions, or when used in conjunction with wall ties. Brickforce® is available in a range of different main wire diameters for specific structural loading situations, and in a variety of product widths to suit different block or brick leaf construction.

To comply with quality assurance requirements and assist in product traceability, each strip of Brickforce® is uniquely marked at regular intervals with the brand name, reference and manufacturing code - 'so it's only Brickforce® if it says it's Brickforce®.'

Specification

Material finishes

- ✓ Stainless steel wire to BS 5628-2.
- ✓ Galvanised steel wire zinc coated to BS EN 10244-2.

Main wires

- ✓ Flattened profile, equivalent diameter to suit design requirements with a minimum characteristic tensile strength of 500 N/mm².



Brickforce® Product References

External Wall (including internal leaf of cavity)		Internal Walls Only (partitions of cross walls)	
Code Reference	Wall Thickness (mm)	Code Reference	Wall Thickness (mm)
SBF30W60	102 brick or 100 block	GBF30W60	102 brick or 100 block
SBF35W60	102 brick or 100 block	GBF35W60	102 brick or 100 block
SBF40W60	102 brick or 100 block	GBF40W60	102 brick or 100 block
SBF45W60	102 brick or 100 block	GBF45W60	102 brick or 100 block
SBF50W60	102 brick or 100 block	GBF50W60	102 brick or 100 block
SBF30W100	140 block	GBF30W100	140 block
SBF35W100	140 block	GBF35W100	140 block
SBF40W100	140 block	GBF40W100	140 block
SBF45W100	140 block	GBF45W100	140 block
SBF50W100	140 block	GBF50W100	140 block
SBF30W150	190/200 block	GBF30W150	190/200 block
SBF35W150	190/200 block	GBF35W150	190/200 block
SBF40W150	190/200 block	GBF40W150	190/200 block
SBF45W150	190/200 block	GBF45W150	190/200 block
SBF50W150	190/200 block	GBF50W150	190/200 block
SBF30W175	215 block	GBF30W175	215 block
SBF35W175	215 block	GBF35W175	215 block
SBF40W175	215 block	GBF40W175	215 block
SBF45W175	215 block	GBF45W175	215 block
SBF50W175	215 block	GBF50W175	215 block

Pack sizes

- ✓ Brickforce® is manufactured in 2.7m long strips and supplied in packs:
- ✓ Stainless steel Brickforce® packs contain 20 strips (54m per pack).
- ✓ Galvanised Brickforce® packs contain 25 strips (67.5m per pack).
- ✓ Minimum overlap 225mm.

Product code describes finish, wire diameter and product width.

ie SBF35W60 =
stainless Brickforce® 3.5 mm dia wire 60 mm wide

GBF40W100 =
galvanised Brickforce® 4.0mm dia wire 100 mm wide

Bricktie

Tying masonry leaves together

Bricktie was developed to overcome the problems associated with lifting heavy blocks in the construction of 215mm and greater thickness walls. The use of Bricktie allows the construction of collar-jointed walls - made up from two thinner blocks in accordance with BS 5628-1. **By tying the two masonry leaves together, the wall may be designed as if it were solid construction.** The use of Bricktie also enables a fair-faced block finish to both sides of the wall by adopting a collar-joint construction. Similarly, a single solid brick wall can be constructed using stretcher bond coursing without the need for any additional ties. Bricktie provides an effective and time-saving solution to most wall combinations and consists of a 20 x 3mm flat tie welded to two longitudinal flattened reinforcing wires. Bricktie is available in widths to suit any required wall make up, although the most common form is 175mm wide Bricktie to suit a 215mm collar-jointed wall constructed from two leaves of 100mm. In addition, the longitudinal wires can be utilised for either structural strength or to extend the distances between movement joints.

Specification

Material finishes

- ✓ Stainless steel wire complying fully with BS 5628-2.
- ✓ Galvanised steel wire zinc coated to BS EN 10244-2.
- ✓ Main wires flattened profile, equivalent diameter to suit design requirements, with a min. characteristic tensile strength of 500 N/mm². Cross piece ties conform to the performance requirements of B5628-1.



Bricktie Product References

Pack sizes

- ✓ Bricktie is supplied as 2.7m long individual strips.
- ✓ Minimum overlap 225mm.



For tying and reinforcing corbelled masonry, Bricktie is widely used. It eliminates the need for steel support systems and will simplify design and construction.

Product Code	Material	Wall Width
SCF35W175	Stainless Steel	215mm
GCF35W175	Galvanised	215mm

For a complete product code, the wire finish and width are also required.

- ie GCF35W175 = galvanised 3.50 mm diameter wires 175 mm wide.
 SCF40W175 = stainless 4.00 mm diameter wires 175 mm wide.

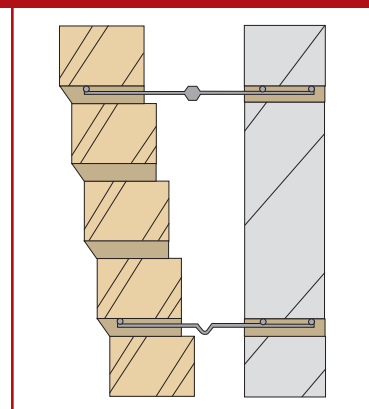

Bricktor® CCR Crack Control Reinforcement.

- Standard masonry joints
- 2-3mm Thin Joint System

To celebrate a century of use since its invention in 1906, Bricktor® has now been re-designed to meet the new demands of 21st century construction techniques. In 2005 new Bricktor® Crack Control Reinforcement known as Bricktor® CCR was launched. It can be used for both **standard masonry joints** and **thin joint systems**.

Originally recognised for its woven format, the cross wires have been redesigned into a square welded format, thereby allowing easier application within the bed joint.

Bricktor® is manufactured from high tensile wire and is designed for bonding and strengthening brickwork, blockwork and stone walls. Available in **stainless steel and galvanised finishes**, in roll lengths of 25m, Bricktor® lies flat on the masonry mortar joint making the product **easy to install** compared to other coiled products.

Although Bricktor® cannot be used structurally, test work carried out has shown its use contributes significantly to enhance the strength of masonry by absorbing tensile stresses which can develop in masonry construction.

Specification

Material finishes

- ✓ Stainless steel wire - Grade 304S15.
- ✓ Galvanised steel - zinc coated 60g/m².

Wire characteristics

- ✓ Longitudinal wires - 1.25mm diameter, cross wires - 0.65mm diameter.



Standard masonry joints



2-3mm Thin Joint System



Our Commitment

Bekaert Technical Advice Service

Our in-house team of masonry reinforcement engineers provides a comprehensive technical advice service for the complete range of masonry reinforcement products.

Free design service for panels, lintels, beams

To use the “free” panel design service, a form must be completed. The form can be found on the back of the Brickforce® Engineers guide or it can be downloaded as a pdf-file from the website - www.bekaert.com/building. Alternatively, please contact the Sales team on 0114 242 7480

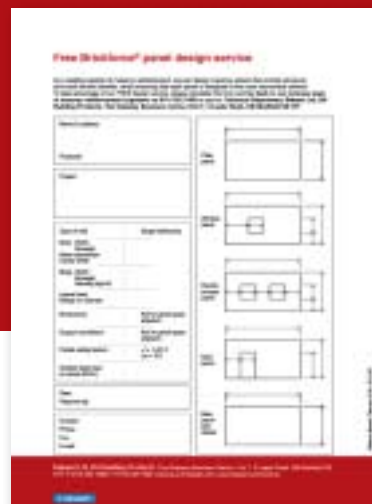

Benefits

- ✓ Bonds and strengthens corners and wall intersections.
- ✓ Resists cracking in areas of uneven settlement.
- ✓ Bonds walls to reinforced concrete frames.
- ✓ Easy folding for corners, curves and angles.
- ✓ Safe to handle and easy to cut and shape on site.

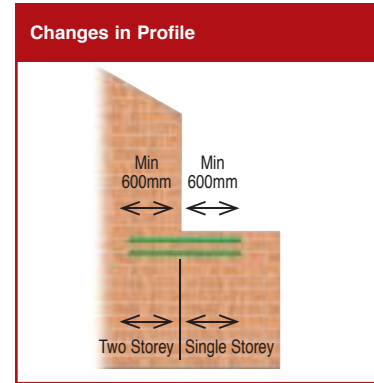
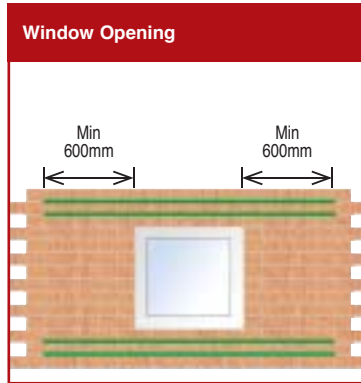

Important notes

- ✓ Two rolls of Bricktor® may be used to reinforce a wider wall by positioning a roll close to each face of the wall, allowing 20mm cover. There is no need to lap rolls side by side.
- ✓ Galvanised Bricktor® is for use in internal walls only. For external walls (including inside leaf of cavity wall) stainless steel Bricktor® must be used.

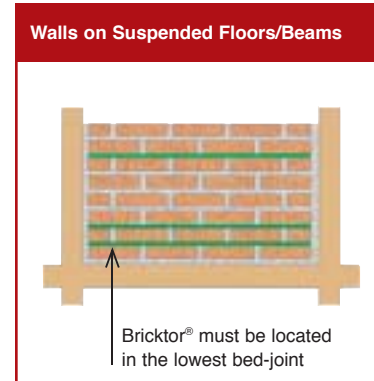
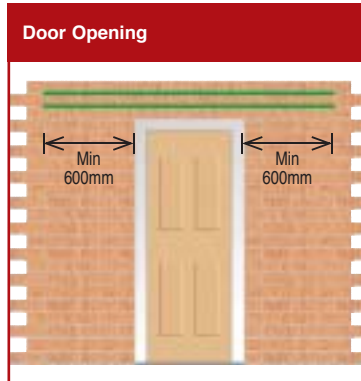

Pack sizes

- ✓ Supplied as 25m roll.
- ✓ Minimum overlap 225mm.

Stainless steel	Galvanised	To suit wall width mm
SBT60CCR	GBT60CCR	100-125
SBT100CCR	GBT100CCR	140-150
SBT160CCR	GBT160CCR	190-200
SBT180CCR	GBT180CCR	215

Note: For wall widths greater than 225mm, a combination of narrower roll widths may be used.



Other Services include:

- ✓ Telephone enquiry service.
- ✓ Office/on-site support and advice.
- ✓ Details and take-offs.

Website

The Bekaert website www.bekaert.com/building provides full details of all our masonry reinforcement products and provides easy access to our technical information.



CPD Seminar

We offer a CPD seminar presentation which covers the design and use of bed joint reinforcement. This is available at lunchtimes or evenings and is suitable for Architects, Clerks of Works, Engineers and Colleges/Universities.

Sales support

- All products are supported by a national team of sales people who are always available to discuss a particular application or project and provide on-site support as required.

Our product range includes:

- Brickforce® - structural masonry reinforcement
- Bricktor® CCR - crack control reinforcement
- Rendalath® - reinforced render carrier system

All brands are registered brands of which NV Bekaert SA is the owner.

